



UNIVERSITY OF CAMBRIDGE INTERNATIONAL EXAMINATIONS  
General Certificate of Education  
Advanced Subsidiary Level and Advanced Level

www.PapaCambridge.com

---

**THINKING SKILLS**

**9694/11**

Paper 1 Problem Solving

**October/November 2011**

**1 hour 30 minutes**

Additional Materials:      Multiple Choice Answer Sheet  
   Soft clean eraser  
   Soft pencil (type B or HB is recommended)

\* 9 7 2 0 8 6 9 8 6 7 \*

---

**READ THESE INSTRUCTIONS FIRST**

Write your Centre number, candidate number and name on all the work you hand in.

There are **30** questions on this paper. Answer **all** the questions.

For each question there are four possible answers **A, B, C** and **D**. Choose the **one** you consider correct and record your choice in pencil on the separate answer sheet.

**Read very carefully the instructions on the answer sheet. Ignore responses numbered 31 – 40 on the answer sheet.**

**INFORMATION FOR CANDIDATES**

Each correct answer will score one mark. A mark will not be deducted for a wrong answer.

---

This document consists of **20** printed pages.



1

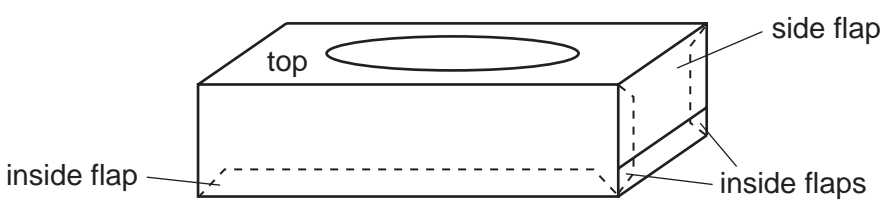

A cardboard container for tissue handkerchiefs as shown above is made up of one piece of cardboard cut and folded to the necessary shape and glued together. The two ends are overlapped and glued and the base is secured to the facing side on the diagram by a glued flap folded from the base. The top has an oval hole which allows the tissues to be withdrawn.

Which one of the four diagrams below represents the outline of the piece of cardboard?

A

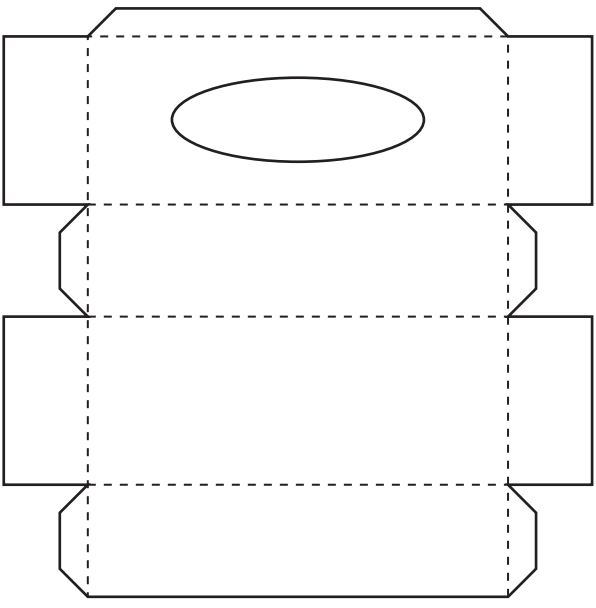

B

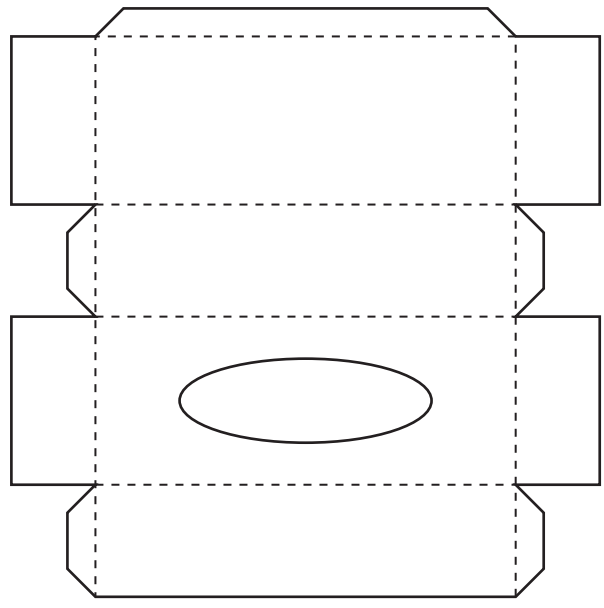

C

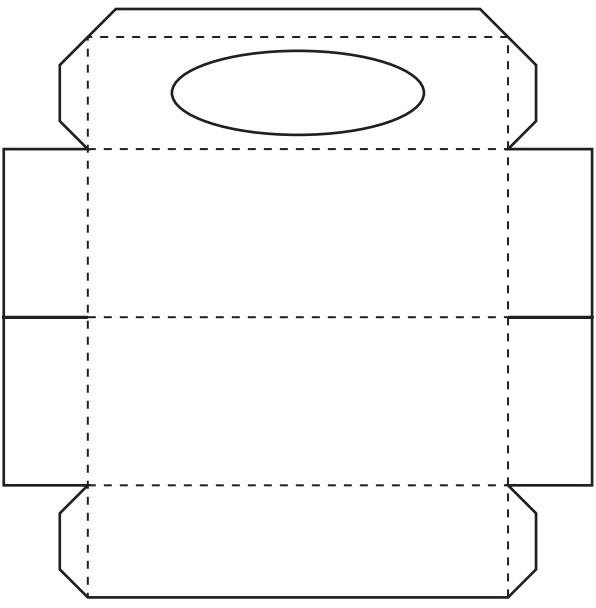

D

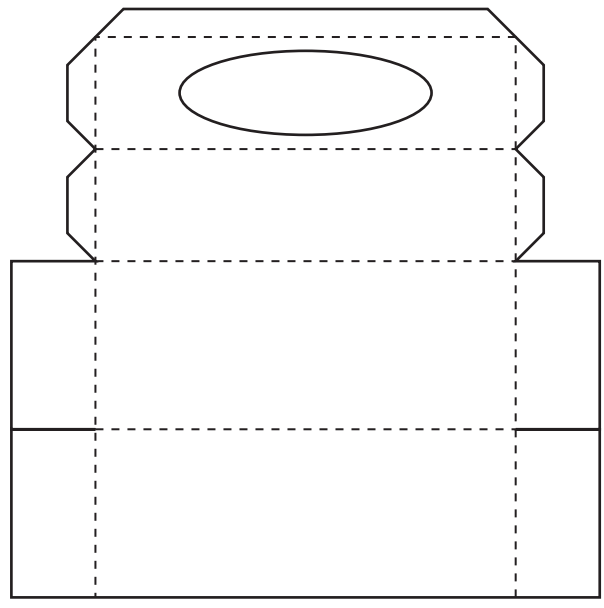

- 2 Imperfections in the manufacturing process mean that there are slight variations in the dimensions of machined parts. The range of the sizes of the parts in four batches of shafts and holes was measured accurately.

Which one of the four batches shown below will contain parts such that some of the shafts will fit in all the holes?

	<i>Range of shaft sizes</i>	<i>Range of hole sizes</i>
<i>Batch 1</i>	50.000 – 50.100	50.000 – 50.050
<i>Batch 2</i>	49.900 – 50.000	50.010 – 50.050
<i>Batch 3</i>	49.900 – 49.950	50.000 – 50.050
<i>Batch 4</i>	49.900 – 49.950	49.950 – 50.000

- A Batch 1  
 B Batch 2  
 C Batch 3  
 D Batch 4
- 3 A toy for children comprises two different kinds of blocks that can be placed on top of each other, a hexagon and a rectangle shape.

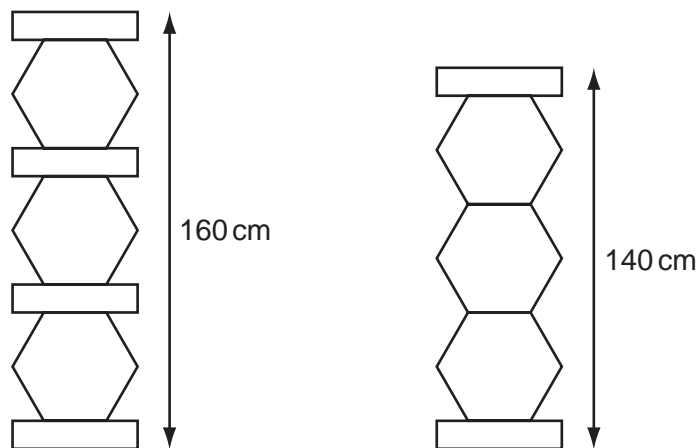

What is the height of the hexagon shape?

- A 10 cm  
 B 25 cm  
 C 28 cm  
 D 40 cm

- 4 The tourism office has decided to allow companies to sell models of the town hall as souvenirs to visitors. They have decided that the guide price should be \$2.50 per model for the first 10 models, and \$1.00 per model thereafter. The companies are allowed to vary their prices by up to 20% above or below the guide price.

In which one of the following graphs does the shaded region represent the range of incomes that the companies can expect to receive for the models?

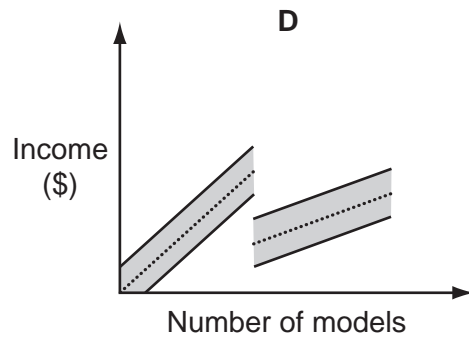
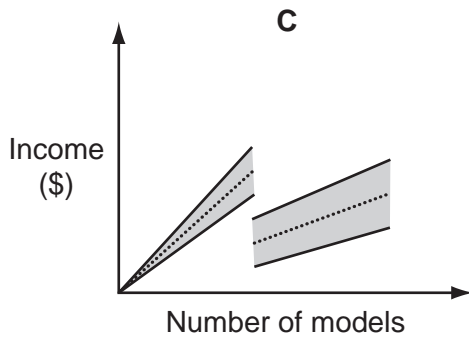
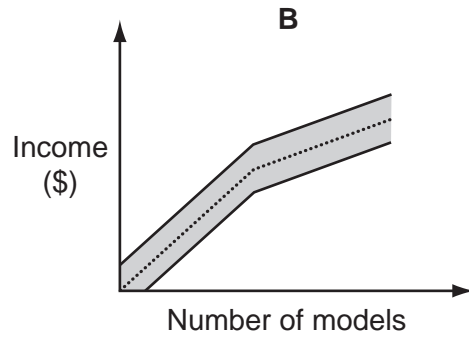
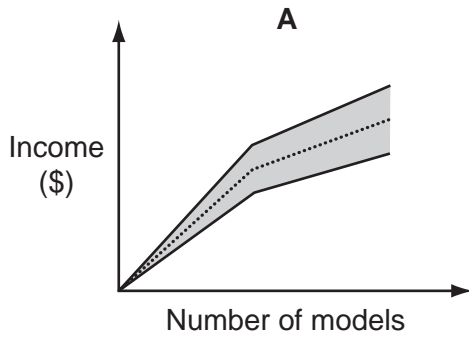

- 5 I drive 120 000 km every year and I want to reduce costs on tyres. Tyres wear unevenly unless tracking is done. Tracking costs \$20 for the whole set of four tyres, and has to be done after every 40 000 km or the tyres will wear unevenly and will only last another 10 000 km. Tracking is provided free when you buy a new set of four tyres.

I need a new set of four tyres on my car which I am only keeping for a year until I sell it on. The following are details of the cost of different kinds of tyres and their lifespan. I have decided that when I choose an option, I will only use one kind of tyre.

<i>Tyre</i>	<i>Price in \$ per tyre</i>	<i>Lifespan in km</i>
Sidon	55	40 000
Tredwell	70	60 000
Groundhug	80	80 000
Werewell	135	120 000

How much is the minimum I have to pay for tyres and tracking for the next year?

- A \$560
- B \$580
- C \$600
- D \$660

- 6 I buy my sandwiches for each day from the work canteen. The prices are shown below.

<i>Filling</i>	<i>Small roll</i>	<i>Large roll</i>	<i>Baguette</i>
Cheese	\$1.00	\$1.20	\$1.50
Egg	\$1.20	\$1.50	\$1.80
Beef	\$1.80	\$2.00	\$2.20
Chicken	\$1.80	\$2.00	\$2.50
Ham	\$2.00	\$2.50	\$2.80
Pork	\$2.20	\$2.50	\$2.80
For salad add	20¢	30¢	50¢

I plan to have a large cheese roll on Monday and Thursday, a chicken baguette with salad on Tuesday and a large egg roll on Wednesday and Friday.

The canteen has a special offer: if I order all of my sandwiches for the week then I will get the cheapest one free.

How much will I need to pay for my sandwiches for the week?

- A \$6.00  
 B \$6.70  
 C \$7.20  
 D \$8.40
- 7 A teacher was organising a trip to a conference. The law states that you have to have a ratio of 1 member of staff to 15 students. The conference organisers allow 1 free member of staff per 8 students. The coach company offered to take students in either a 40-seater bus for \$300 or a 65-seater bus for \$350.

The teacher left the college and all the paperwork disappeared. The school's accountant needed to have some idea of the cost of the trip but all she knew was that only 4 teachers went on it (all having free places), and that the fee per student was \$15, which the college paid.

What did she work out was the difference between the lowest and highest possible cost of the trip?

- A \$420  
 B \$470  
 C \$780  
 D \$840

- 8 Stanley and Walter are two old friends who have recently discovered the art of texting. They can't cope with text language, but, when communicating with each other, they use a code that Stanley invented many years ago.

The code is a substitution code with a twist. When a particular letter appears for the first time in a message it is encoded as the next letter in the alphabet (A becomes B, Z becomes A). On each subsequent appearance it becomes the next letter again (A becomes C, Z becomes B).

For example:

ARE YOU AT HOME TODAY?

encodes as

BSF ZPV CU IQNG VREDA?

Stanley is about to text Walter with the following message.

THE CONCERT TONIGHT STARTS AT HALF PAST SEVEN

How will Stanley encode the word SEVEN?

- A WHWHQ
- B WHWIQ
- C WHXHQ
- D WHXIQ

- 9 When out driving I came across the two signs shown below uprooted and on the crossroads. Clearly one of the signs did not belong to the crossroads at which I had just come from Kaali and had not been through any of the other towns.

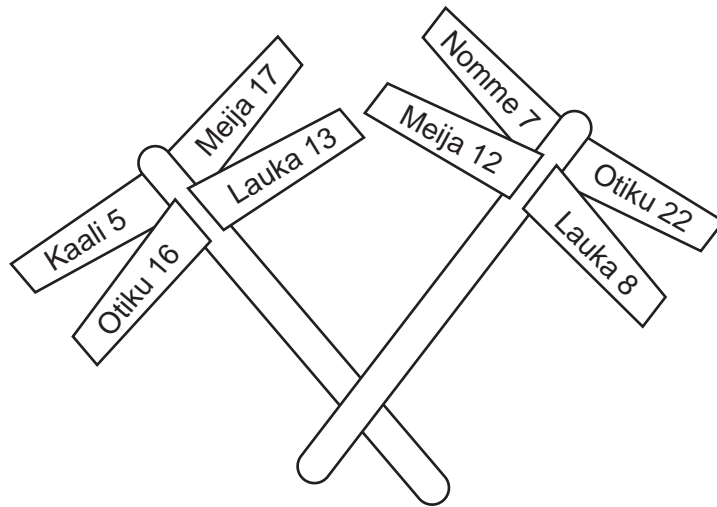

Assuming that one of the signs belonged at the crossroads where I found them, which way should I go for the shortest route to Nomme?

- A Left
- B Right
- C Straight on
- D There is not enough information



- 10 Two examples of pyramid puzzles are shown below. The sum of the values of two boxes placed in the box above and so on. The object is to find all the values to the top of the pyramid. The values of  $w$ ,  $x$ ,  $y$ ,  $z$  are not necessarily the same in both puzzles.

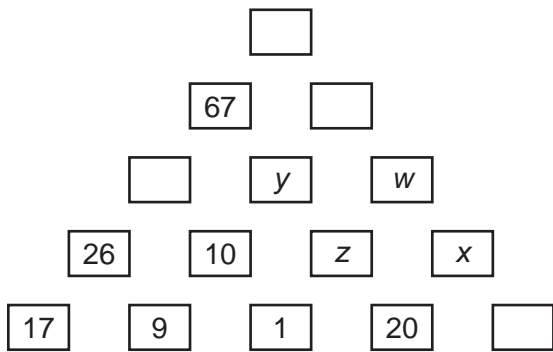

Pyramid 1

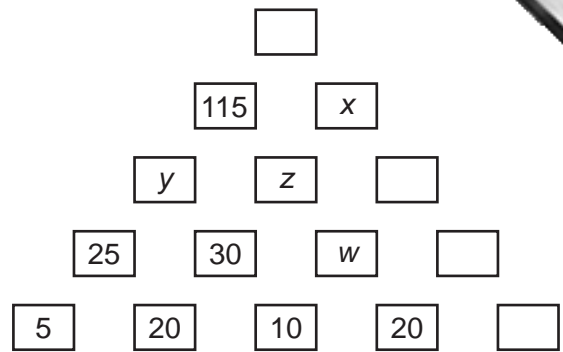

Pyramid 2

Which one of the following, if given, will enable all the box values to be found for both pyramid puzzles?

- A The value of  $w$  in each puzzle.
  - B The value of  $x$  in each puzzle.
  - C The value of  $y$  in each puzzle.
  - D The value of  $z$  in each puzzle.
- 11 Four women (Ada, Babs, Cath and Dee) and four men (Mac, Nick, Oscar and Pete) are sitting evenly spaced around a circular table. No woman sits next to another woman. Pete is opposite Nick, who is sitting next to Ada, and she is opposite Babs, who sits next to Mac. Oscar is next to Dee.

Who is Cath between?

- A Mac and Pete
- B Nick and Mac
- C Oscar and Nick
- D Pete and Oscar

- 12 Every month, when I pay my rent, the landlord gives me a bill for utilities. I know that the extra charges are included in my monthly rent, so my extra bill for each utility is calculated by multiplying the number of units that I have used by the price per unit. I do not know which utility is electricity and water I am being charged for. In the last four months I have recorded the number of units of each that I used and the amount that I was charged by the landlord.

<i>Electricity (units)</i>	<i>Gas (units)</i>	<i>Water (units)</i>	<i>Landlord's bill (\$)</i>
50	71	32	2.77
53	71	34	2.81
50	71	28	2.69
54	74	35	2.92

What am I being charged for?

- A** Electricity and gas.
- B** Electricity and water.
- C** Gas and water.
- D** Electricity, gas and water.
- 13 I want to buy a box of chocolates as a gift for a friend. There are 5 different types of chocolate that I can choose. The prices are  $2\phi$ ,  $4\phi$ ,  $8\phi$ ,  $10\phi$  and  $16\phi$  per chocolate. The box will hold 24 chocolates in total and I am allowed to select any combination of chocolates to fill the box. I will not necessarily buy all 5 types of chocolate, but I want to make sure that, for each type of chocolate I buy, there are at least 4 chocolates and no more than 6. I want the price of the box to be as close as possible to \$1.50.

How far from \$1.50 will the price of my box be?

- A**  $0\phi$
- B**  $4\phi$
- C**  $6\phi$
- D**  $10\phi$

- 14 1 litre of 'Orange Burst' paint is made by mixing red and yellow paint in the ratio 2 : 3. When mixing the paint mistakenly reverses the ratio of red to yellow. The mistake can be corrected by adding an amount of yellow paint.

How much yellow paint must be added to the 1 litre mixture to obtain the correct colour for 'Orange Burst' paint?

- A 0.4 litres  
 B 0.5 litres  
 C 0.6 litres  
 D 0.9 litres
- 15 Pantech is introducing a new generation of televisions. Its projected unit sales for the old model to be phased out and the new model to be phased in are shown for the next three years.

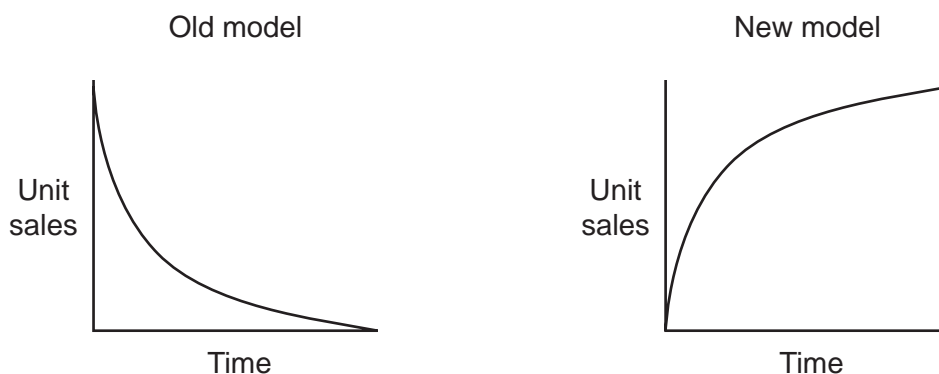

Which one of the graphs below could represent the total unit sales of televisions over this period? (All graphs are drawn to the same scale.)

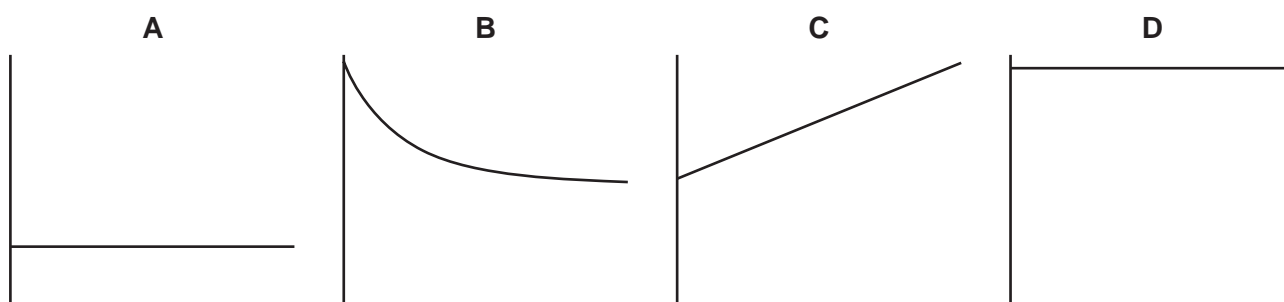

- 16 A railway station platform is 150 metres long. A train passing through the station is 100 metres long including the locomotive. The front of the train passes one end of the platform at 10 o'clock exactly and the rear of the train passes the other end of the platform 15 seconds later.

What is the speed of the train in kilometres per hour?

- A 24 km/h  
 B 36 km/h  
 C 48 km/h  
 D 60 km/h

- 17** In the first section of the TV Quiz Show “Guess If You Dare”, three contestants are asked the same 12 general knowledge questions. For every question, each contestant in turn chooses one of the 3 options given, or elects to pass. The order in which they answer is rotated from question to question. When a contestant gives an answer, it is heard by the other two.

Points are awarded as follows:

correct answer	=	+3 points
incorrect answer	=	-4 points
pass	=	-1 point

The contestant with the lowest score from the 12 questions is then eliminated.

After 11 questions in the first section of today’s show the scores are:

Peter	19 points
Paul	18 points
Mary	17 points

It is Paul’s turn to be last to choose his answer to the 12th question. Peter and Mary have already chosen different options, and Paul has no idea at all what the correct answer is.

What should Paul do to ensure that he does not finish last?

- A** Choose the third option
  - B** Give the same answer as Mary
  - C** Give the same answer as Peter
  - D** Pass
- 18** During my holiday in Bolandia I want to see the Great Kings, four spectacular waterfalls known as Alexander, Charles, Darius and Frederick.

I have been told that the sum of the heights of Charles and Darius is exactly twice the height of Alexander, whilst the sum of the heights of Darius and Frederick is exactly three times the height of Alexander.

Based on what I have been told, which is the only one of the following that can be confirmed?

- A** Alexander’s height is greater than Charles’s.
- B** Charles’s height is greater than Darius’s.
- C** Darius’s height is greater than Frederick’s.
- D** Frederick’s height is greater than Alexander’s.

- 19** A motor car assembly plant has a target of completing 3000 four-wheeled cars a month. The car parts stopping the target from being met this month are the tyres. Due to production problems with the main tyre supplier, they will only deliver 7000 tyres this month. However, two other suppliers, who were scheduled to supply 1000 and 2500 tyres respectively, will increase their delivery of tyres by 20% to meet the shortfall. A thinner type is used for spare tyres, and the plant has plenty of these.

How many cars short of the target will they be this month?

- A** 200
  - B** 375
  - C** 800
  - D** 1075
- 20** A non-stop train service connects Parlour and Scullery, the two largest towns in Roonania. The journey distance is 57 kilometres.

Trains depart from the stations at Parlour and Scullery simultaneously, once an hour. Their speed is restricted to 30 kilometres per hour while they are within 3 kilometres of Parlour station, and 45 kilometres per hour while they are within 3 kilometres of Scullery station; otherwise they travel at 90 kilometres per hour.

How far from Parlour station are the two trains when they pass each other?

- A** 22 kilometres
- B** 24 kilometres
- C** 27 kilometres
- D** 28 kilometres

21 The two identical dice that come with the board game "Romance" differ from conventional dice in two ways:

- the numbers on the faces run from 0 (a blank face) to 5, with opposite faces always adding up to 5;
- the spots are in the shape of hearts.

This is how the dice appear at present, following the last player's throw.

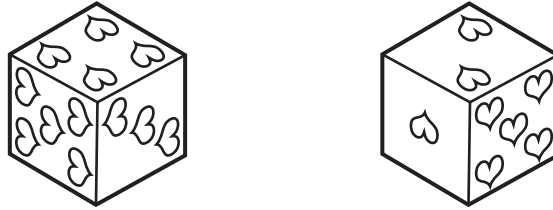

Which one of the following could be the appearance of one of the dice after the next player's throw?

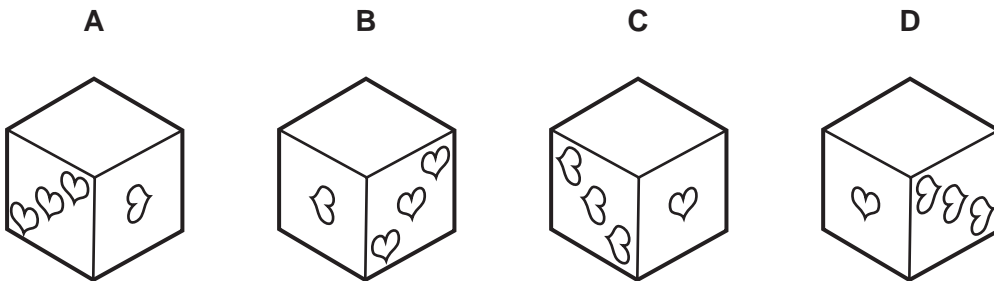

- 22 Trains leave Newport towards Oldcastle at regular intervals. The arrival and departure times for the first train are shown below.

	<i>Arrive</i>	<i>Depart</i>
<i>Newport</i>		09:10
<i>Clonton</i>	09:24	09:27
<i>Middleton</i>	09:33	09:35
<i>Redmoor</i>	09:54	09:56
<i>Dullon</i>	10:15	10:16
<i>Oldcastle</i>	10:36	

Once trains reach Oldcastle they wait for a few minutes before starting on the return journey to Newport. All trains wait for the same number of minutes at Oldcastle before they start the return journey, and they travel at the same speed in each direction. On its return journey, the first train arrives at its first stop (Dullon) at the same time as the second train to have left Newport (which is still on its way to Oldcastle). Dullon is the only station at which any two trains ever meet. When trains arrive back at Newport they wait until the next departure time before leaving.

Which one of the following pieces of information would **not** be sufficient to work out the time that the first train left Oldcastle?

- A The amount of time between train departures from Newport.
- B The time at which the second train leaves Redmoor on its return journey.
- C The time at which the first train leaves Newport for the second time.
- D The time at which the first train arrived back at Newport.

23 Books can be borrowed from the library for 2 weeks at a time. Books are always out for at least one week but are often returned after just one week rather than two. During the last 4 weeks the following numbers of books have been taken out.

- Week 1 – 40
- Week 2 – 32
- Week 3 – 43
- Week 4 – 28

All of the books were returned on time, or early.

Which one of the bar charts could **not** represent the number of books that were out of the library at the start of each week?

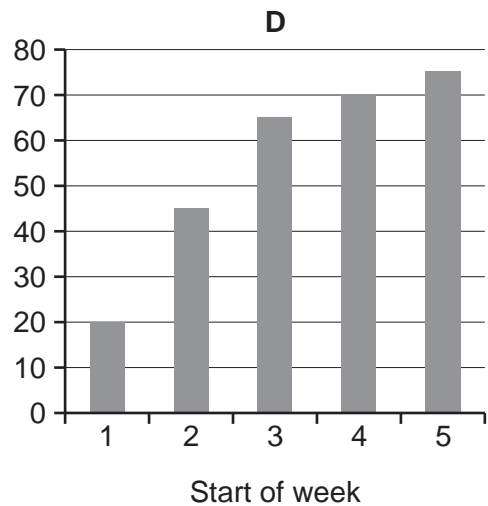
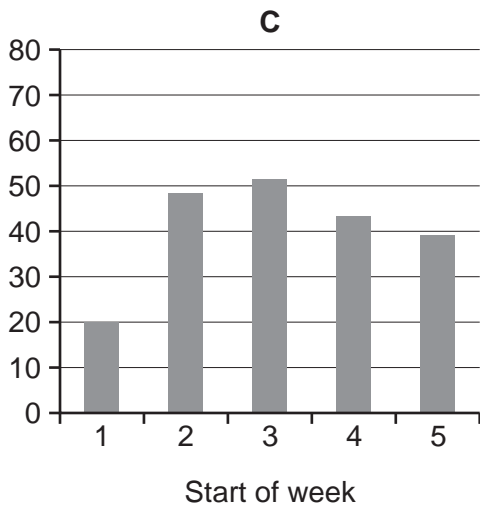
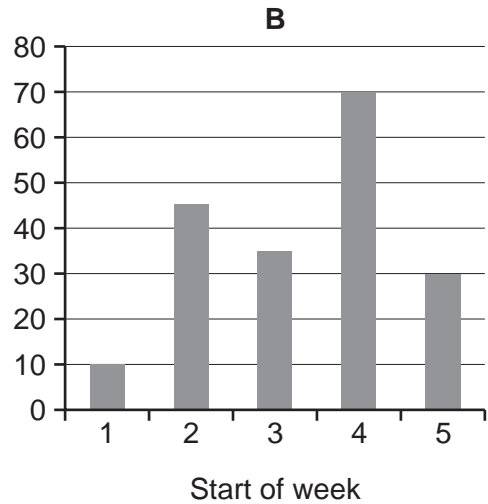
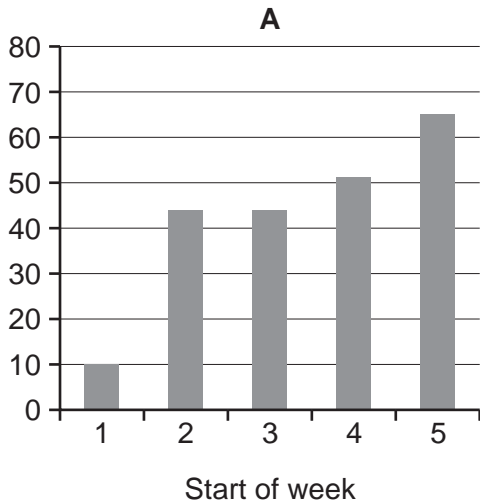



- 24** There are two taxi companies in my town. One taxi company charges a fixed charge of \$1.00, plus a further 10¢ for each complete kilometre travelled. The second company charges a fixed charge of \$1.00, plus a further 10¢ for each complete 500 metres travelled. Yesterday I took a taxi to the supermarket and back. I used one company on the way out and the other company on the way back. Both taxis took the same route. The total cost of my two journeys was \$4.60.

What is the smallest price I could have paid for my two journeys if I had used the cheaper taxi company?

- A** \$2.60
  - B** \$3.10
  - C** \$3.60
  - D** \$4.20
- 25** I need to send 7 items through the post. I can send each item on its own or in a parcel with another item. However, no parcel can ever contain more than two items. If I send two items together then I add together the postage costs for the two items. The costs to post my items are 9¢, 12¢, 14¢, 15¢, 17¢, 18¢ and 25¢.

I will pay the postage for each parcel with stamps. I have two 1¢ stamps and the rest are all 5¢ stamps so, for example, I would need to pay 20¢ for a parcel that normally costs 18¢ to post, but could pay 17¢ for a 17¢ parcel.

What is the smallest total amount I need to pay to send all of the items?

- A** 110¢
- B** 111¢
- C** 112¢
- D** 115¢

- 26 Four of my friends just got back from the local café having had a long break to sit and talk. Each of them had a different order. Each paid for their own food and drinks and they know that there were no special offers.

They can each remember the total cost of their purchases but not the individual costs for any of the items.

Bill had 1 cup of tea, 2 slices of cake and a cup of hot chocolate.

John had 2 cups of tea and 1 slice of cake.

Karen had 2 cups of tea, 1 slice of cake and a cup of hot chocolate.

Sue had 3 slices of cake and 2 cups of hot chocolate.

I want to work out the individual price of the items, and I have realised that I only need to know the totals of three of the orders as long as one particular order is included in the three.

Which one of the totals must be included in the three that I choose for me to be able to work out the individual prices?

- A Bill's order
  - B John's order
  - C Karen's order
  - D Sue's order
- 27 I have an unusual digital clock that displays the digits as words, not figures.

At 9:40 pm, for example, its appearance is:

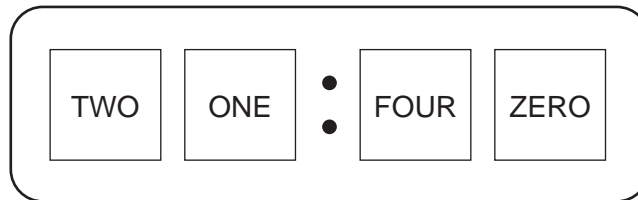

How many times each day does my clock show four different words in alphabetical order from left to right?

- A 2
- B 4
- C 7
- D 10

28 Suspecting that people tend not to buy things that are too cheap (probably because of poor quality), as well as things that are too expensive, Alistair conducted an experiment.

He arranged for 15 shops to sell the same sunglasses at different prices for one month.

These are the results:

<i>Shop descriptor</i>	<i>Price</i>	<i>Number sold</i>
SGA	\$14	75
SGB	\$6	51
SGC	\$26	31
SGD	\$12	71
SGE	\$24	43
SGF	\$2	25
SGG	\$16	78
SGH	\$30	6
SGI	\$22	55
SGJ	\$18	80
SGK	\$4	41
SGL	\$20	68
SGM	\$8	59
SGN	\$28	19
SGO	\$10	66

Which one of the following best fit lines illustrates Alistair's results?

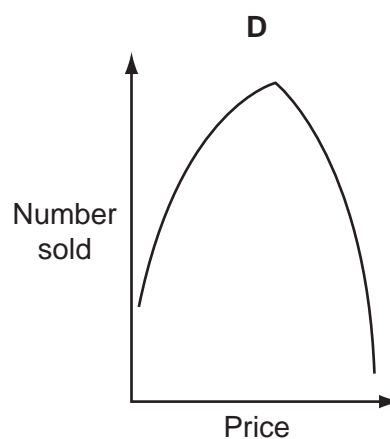
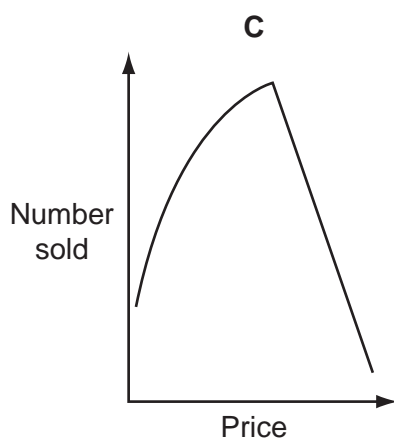
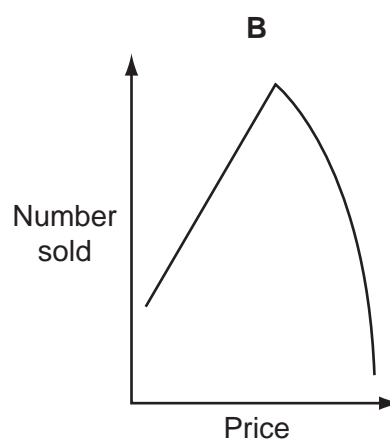
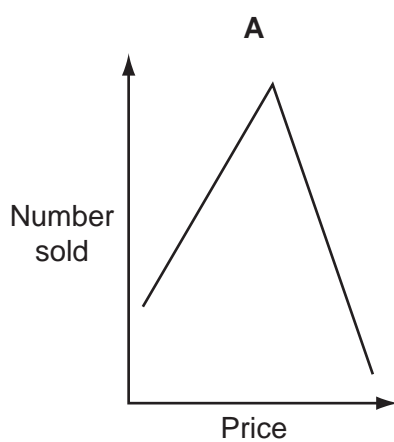

- 29 Charles's journey from his home to his school takes a varying amount of time depending on how early he leaves, the volume of traffic on the roads, the weather, and how late the bus is when it arrives. The longest bus journey time is 35 minutes, the average 25 minutes, and the shortest 15 minutes. The bus, which is timetabled to run every 15 minutes, can be as much as 12 minutes late. He has to arrive at school no later than 08:00 to ensure he is able to go on a school trip.

Given that his walk to the bus stop takes just under two minutes, at what time must he leave home to make sure he is able to go on the school trip?

- A 06:56  
B 07:02  
C 07:06  
D 07:08
- 30 In a cycle time trial, the riders set off at two-minute intervals over a fixed 50 km route and are timed individually. The winner is the rider who completes the course in the shortest time. In one time trial of 64 riders, one cyclist managed to overtake three of the riders who had set out before her, four cyclists overtook two riders, and seven overtook one rider. No cyclist suffered the humiliation of being overtaken by more than one rider, and all riders completed the course.

How many riders, in this time trial, started and finished the course with the same number of riders in front of them?

- A 30  
B 34  
C 46  
D 52